

SERIE 1560-1600

---



**sab**

Cuore e Cervello della porta.

# 202

Chiave STANDARD in ottone nichelato  
Impugnatura in Plastica NERA

FINITURA DI SERIE

- Nichelatura

DOTAZIONE

- Normale dotazione per serrature da infilare e applicare per porte blindate (CH)
- A richiesta per sbocchi di riproduzione

STANDARD key in nickel-plated brass  
BLACK plastic head

STANDARD FINISHINGS

- Nickel-plated

ACCESSORIES

- Supplied as standard with mortice or rim locks for security doors (CH)
- On request blank for making copies

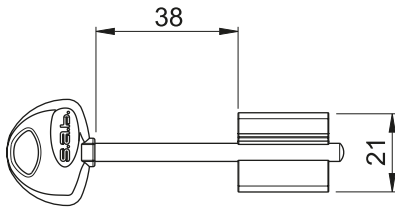

202

Chiave STANDARD in ottone nichelato | Impugnatura in Plastica NERA

STANDARD key in nickel-plated brass | BLACK plastic head

Codice Code	Finitura Finishing
---	---



00202

50

Serie

1560 - Chiavi | Keys

# 204

Chiave CIFRATA in ottone nichelato  
Impugnatura in Plastica NERA

FINITURA DI SERIE

- Nichelatura

DOTAZIONE

- Chiave aggiuntiva alla normale dotazione per serrature da infilare ed applicare per porte blindate (CH)

CODED key in nickel-plated brass  
BLACK plastic head

STANDARD FINISHINGS

- Nickel-plated

ACCESSORIES

- In addition to standard supplies with mortice or rim locks for security doors (CH)

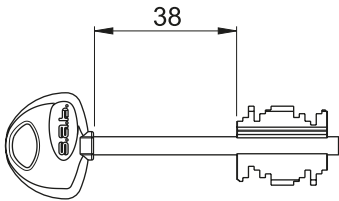

204

Chiave CIFRATA in ottone nichelato | Impugnatura in Plastica NERA

CODED key in nickel-plated brass | BLACK plastic head

Codice Code	Finitura Finishing
---	---



00204

1

# 206

Chiave CIFRATA AL CAMPIONE in ottone nichelato  
Impugnatura in Plastica NERA

FINITURA DI SERIE

- Nichelatura

DOTAZIONE

- Per serrature da infilare ed applicare per porte blindate (CH)

CODED TO SAMPLE key in nickel-plated brass  
BLACK plastic head

STANDARD FINISHINGS

- Nickel-plated

ACCESSORIES

- With mortice or rim locks for security doors (CH)

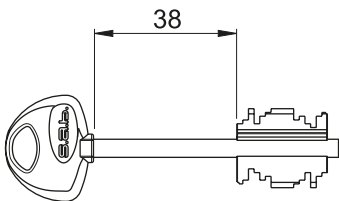

206

Chiave CIFRATA AL CAMPIONE in ottone nichelato | Impugnatura in Plastica NERA

CODED TO SAMPLE key in nickel-plated brass | BLACK plastic head

Codice Code	Finitura Finishing
---	---



00206

1

Serrature per porte blindate

Security door locks

## 202/L

Chiave LUNGA in ottone nichelato  
Impugnatura in Plastica NERA

### FINITURA DI SERIE

- Nichelatura

### DOTAZIONE

- A richiesta (senza variazione di prezzo) per serrature da infilare ed applicare per porte blindate (CHL)
- A richiesta per sbocchi di riproduzione

LONG key in nickel-plated brass  
BLACK plastic head

### STANDARD FINISHINGS

- Nickel-plated

### ACCESSORIES

- On request with mortice or rim locks for security doors (CHL)
- On request blank for making copies

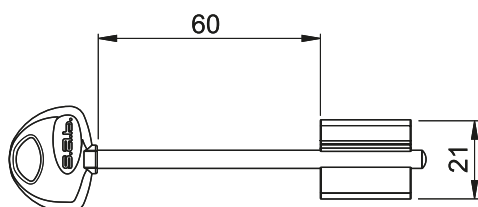

202/L		Chiave LUNGA in ottone nichelato   Impugnatura in Plastica NERA	
LONG key in nickel-plated brass   BLACK plastic head			
Codice Code	Finitura Finishing		
00202L	---	50	

## 204/L

Chiave LUNGA CIFRATA in ottone nichelato  
Impugnatura in Plastica NERA

### FINITURA DI SERIE

- Nichelatura

### DOTAZIONE

- Chiave aggiuntiva alla normale dotazione per serrature da infilare ed applicare per porte blindate (CHL)

LONG CODED key in nickel-plated brass  
BLACK plastic head

### STANDARD FINISHINGS

- Nickel-plated

### ACCESSORIES

- In addition to standard supplies with mortice or rim locks for security doors (CHL)

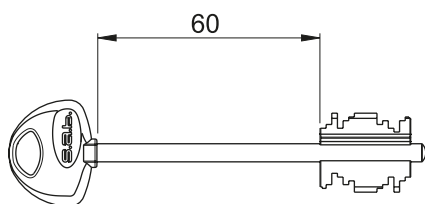

204/L		Chiave LUNGA CIFRATA in ottone nichelato   Impugnatura in Plastica NERA	
LONG CODED key in nickel-plated brass   BLACK plastic head			
Codice Code	Finitura Finishing		
00204L	---	1	

## 206/L

Chiave LUNGA CIFRATA AL CAMPIONE in ottone nichelato  
Impugnatura in Plastica NERA

### FINITURA DI SERIE

- Nichelatura

### DOTAZIONE

- Per serrature da infilare ed applicare per porte blindate (CHL)

LONG CODED TO SAMPLE key in nickel-plated brass  
BLACK plastic head

### STANDARD FINISHINGS

- Nickel-plated

### ACCESSORIES

- With mortice or rim locks for security doors (CHL)

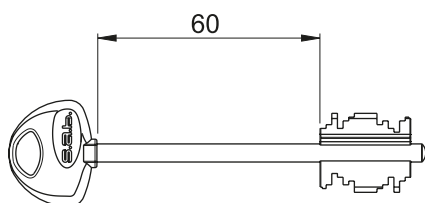

206/L		Chiave LUNGA CIFRATA AL CAMPIONE in ottone nichelato   Impugnatura in Plastica NERA	
LONG CODED TO SAMPLE key in nickel-plated brass   BLACK plastic head			
Codice Code	Finitura Finishing		
00206L	---	1	



# 208/C

Chiave LUNGA CIFRATA DA CANTIERE in ottone nichelato  
AZIONAMENTO SOLO SCROCCO  
Impugnatura in Plastica ROSSA

**FINITURA DI SERIE**

- Nichelatura

**DOTAZIONE**

- A richiesta per serrature da infilare ed applicare per porte blindate (CHL/C)

*LONG CODED SITE key in nickel-plated brass  
FOR ACTIVATING ONLY THE LATCH  
RED plastic head*

**STANDARD FINISHINGS**

- Nickel-plated

**ACCESSORIES**

- With mortice or rim locks for security doors (CHL/C)

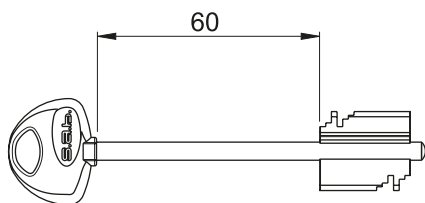

208/C

Chiave LUNGA CIFRATA DA CANTIERE in ottone nichelato | AZIONAMENTO SOLO SCROCCO | Impugnatura in Plastica ROSSA

*LONG CODED SITE key in nickel-plated brass | FOR ACTIVATING ONLY THE LATCH | RED plastic head*

Codice Code	Finitura Finishing
---	---

00208C



1

# 210/2C

Chiave CIFRATA DI SERVIZIO in ottone nichelato  
AZIONAMENTO SCROCCO E PRIME DUE MANDATE CATENACCIO  
Impugnatura in Plastica ROSSA

**FINITURA DI SERIE**

- Nichelatura

**DOTAZIONE**

- A richiesta per serrature da infilare ed applicare per porte blindate (CH/2C)

*CODED SERVICE key in nickel-plated brass  
FOR ACTIVATING LATCH AND FIRST TWO KEY TURNS  
RED plastic head*

**STANDARD FINISHINGS**

- Nickel-plated

**ACCESSORIES**

- With mortice or rim locks for security doors (CH/2C)

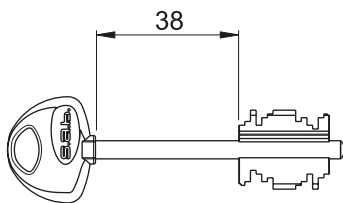

210/2C

Chiave CIFRATA DI SERVIZIO in ottone nichelato | AZIONAMENTO SCROCCO E PRIME DUE MANDATE CATENACCIO | Impugnatura in Plastica ROSSA

*CODED SERVICE key in nickel-plated brass | FOR ACTIVATING LATCH AND FIRST TWO KEY TURNS | RED plastic head*

Codice Code	Finitura Finishing
---	---

002102C



1

# 210/L2C

Chiave CIFRATA LUNGA DI SERVIZIO in ottone nichelato  
AZIONAMENTO SCROCCO E PRIME DUE MANDATE CATENACCIO  
Impugnatura in Plastica ROSSA

**FINITURA DI SERIE**

- Nichelatura

**DOTAZIONE**

- A richiesta per serrature da infilare ed applicare per porte blindate (CHL/2C)

*LONG CODED SERVICE key in nickel-plated brass  
FOR ACTIVATING LATCH AND FIRST TWO KEY TURNS  
RED plastic head*

**STANDARD FINISHINGS**

- Nickel-plated

**ACCESSORIES**

- With mortice or rim locks for security doors (CHL/2C)

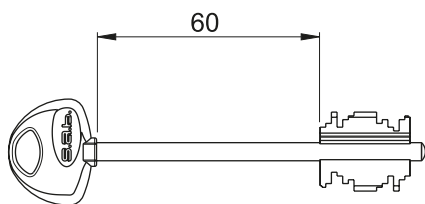

210/L2C

Chiave CIFRATA LUNGA DI SERVIZIO in ottone nichelato | AZIONAMENTO SCROCCO E PRIME DUE MANDATE CATENACCIO | Impugnatura in Plastica ROSSA

*LONG CODED SERVICE key in nickel-plated brass | FOR ACTIVATING LATCH AND FIRST TWO KEY TURNS | RED plastic head*

Codice Code	Finitura Finishing
---	---

00210L2C



1

# 230

Gruppi gorges CAMBIO CIFRATURA  
 Chiavi cifrate in ottone nichelato  
 Impugnatura in Plastica NERA

**FINITURA DI SERIE**

- Chiave nichelata

**DOTAZIONE**

- Ricambio per serrature da infilare ed applicare per porte blindate

*Code plate groups (Gorges)  
 Coded keys in nickel-plated brass  
 BLACK plastic head*

**STANDARD FINISHINGS**

- Key Nickel-plated

**ACCESSORIES**

- Spare part with mortice or rim locks for security doors

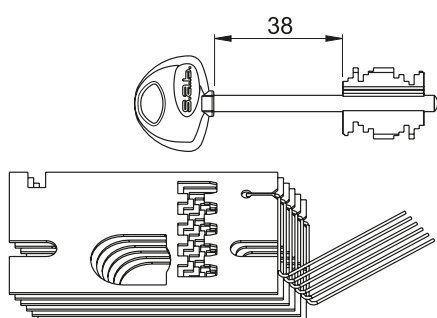

## 230

Gruppi gorges CAMBIO CIFRATURA | Chiavi cifrate in ottone nichelato | Impugnatura in Plastica NERA

*Code plate groups (Gorges) | Coded keys in nickel-plated brass | BLACK plastic head*

Codice Code	Finitura Finishing			
002303C	---	3		
002305C	---	5	1	

# 230/L

Gruppi gorges CAMBIO CIFRATURA  
 Chiavi lunghe cifrate in ottone nichelato  
 Impugnatura in Plastica NERA

**FINITURA DI SERIE**

- Chiave nichelata

**DOTAZIONE**

- Ricambio per serrature da infilare ed applicare per porte blindate

*Code plate groups (Gorges)  
 Long coded keys in nickel-plated brass  
 BLACK plastic head*

**STANDARD FINISHINGS**

- Key Nickel-plated

**ACCESSORIES**

- Spare part with mortice or rim locks for security doors

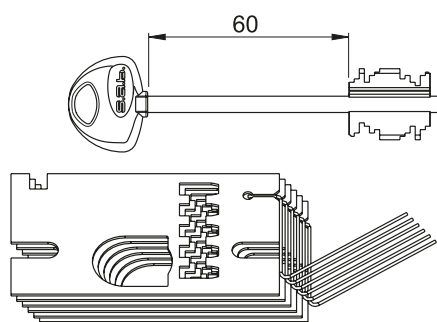

## 230/L

Gruppi gorges CAMBIO CIFRATURA | Chiavi lunghe cifrate in ottone nichelato | Impugnatura in Plastica NERA

*Code plate groups (Gorges) | Long coded keys in nickel-plated brass | BLACK plastic head*

Codice Code	Finitura Finishing			
002303L	---	3		
002305L	---	5	1	

Serie 1560 - Chiavi | Keys



Serrature per porte blindate  
 Security door locks



# 1561/28 - 1561/37

Serratura a Doppia Mappa da infilare  
4 mandate | Triplice chiusura  
Catenaccio a pioli e scrocco

Double Bitted key mortice lock  
4 turns | Triple locking  
Bolt with pins and scrocco

## SCROCCO REVERSIBILE

## REVERSIBLE LATCH

### FINITURA DI SERIE

### STANDARD FINISHINGS

- Scatola e coperchio in acciaio zincato
- Piastra frontale, catenaccio e scrocco in acciaio cromato

- Box and cover in galvanised steel
- Front plate, bolt and latch in chrome-plated steel

### DOTAZIONE

### ACCESSORIES

- 3 chiavi cifrate Art. 204
- Coppia Bocchette con viti Art. 280DM
- 
- 1561/28G Serratura predisposta al montaggio della guida chiave (a richiesta).

- 3 keys Art. 204 (coded)
- Pair of escutcheons with screws Art. 280DM
- 
- 1561/28G Lock predisposed for mounting key slot (On request).

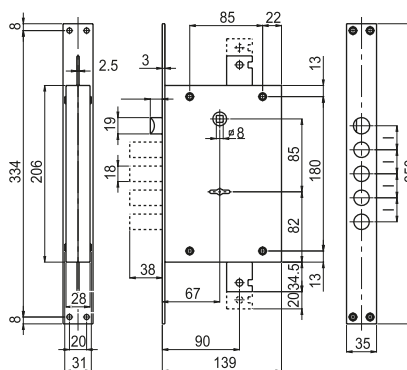

I = 28 / 37

Serie  
1560-1600



Serrature per porte blindate  
Security door locks

1561		Serratura a Doppia Mappa da infilare   4 mandate   Triplice chiusura   Catenaccio a pioli e scrocco   SCROCCO REVERSIBILE						
		Double Bitted key mortice lock   4 turns   Triple locking   Bolt with pins and latch   REVERSIBLE LATCH						
Codice Code	Finitura Finishing							
01561 280 3C 0 OL	---	4	3	35x3x350	28	0,5 - 38	1	8
01561 370 3C 0 OL	---	4	3	35x3x350	37	0,5 - 38	1	8



# 1562/28 - 1562/37

Serratura a Doppia Mappa da infilare  
4 mandate  
Catenaccio a pioli

Double Bitted key mortice lock  
4 turns  
Bolt with pins

## SCROCCO REVERSIBILE

## REVERSIBLE LATCH

### FINITURA DI SERIE

- Scatola e coperchio in acciaio zincato
- Piastra frontale, catenaccio in acciaio cromato

### STANDARD FINISHINGS

- Box and cover in galvanised steel
- Front plate, bolt and latch in chrome-plated steel

### DOTAZIONE

- 3 chiavi cifrate Art. 204
- Coppia Bocchette con viti Art. 280DM
- 
- 1562/28G Serratura predisposta al montaggio della guida chiave (a richiesta).

### ACCESSORIES

- 3 keys Art. 204 (coded)
- Pair of escutcheons with screws Art. 280DM
- 
- 1562/28G Lock predisposed for mounting key slot (On request).

Serie 1560-1600

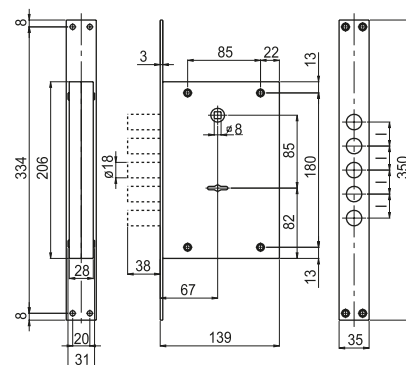

I = 28 / 37

Serrature per porte blindate  
Security door locks

1562		Serratura a Doppia Mappa da infilare   4 mandate   Catenaccio a pioli   SCROCCO REVERSIBILE						
1562		Double Bitted key mortice lock   4 turns   Bolt with pins   REVERSIBLE LATCH						
Codice Code	Finitura Finishing							
01562 280 3C 0 OL	---	4	3	35x3x350	28	0,5 - 38	1	8
01562 370 3C 0 OL	---	4	3	35x3x350	37	0,5 - 38	1	8

# 1563/28 - 1563/37

Serratura a Doppia Mappa da infilare  
4 mandate | Triplice chiusura  
Catenaccio a pioli

Double Bitted key mortice lock  
4 turns | Triple locking  
Bolt with pins

## SCROCCO REVERSIBILE

## REVERSIBLE LATCH

### FINITURA DI SERIE

### STANDARD FINISHINGS

- Scatola e coperchio in acciaio zincato
- Piastra frontale, catenaccio in acciaio cromato

- Box and cover in galvanised steel
- Front plate, bolt and latch in chrome-plated steel

### DOTAZIONE

### ACCESSORIES

- 3 chiavi cifrate Art. 204
- Coppia Bocchette con viti Art. 280DM
- 
- 1563/28G Serratura predisposta al montaggio della guida chiave (a richiesta).

- 3 keys Art. 204 (coded)
- Pair of escutcheons with screws Art. 280DM
- 
- 1563/28G Lock predisposed for mounting key slot (On request).

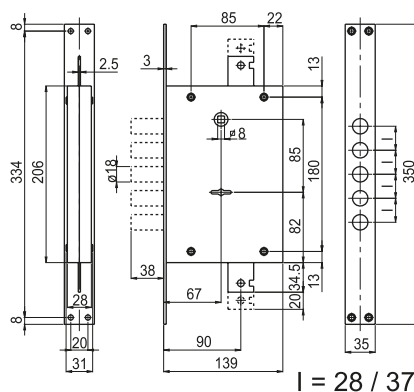

Serie  
1560-1600



Serrature per porte blindate  
Security door locks

1563		Serratura a Doppia Mappa da infilare   4 mandate   Triplice chiusura   Catenaccio a pioli   SCROCCO REVERSIBILE						
Codice Code	Finitura Finishing							
01563 280 3C 0 OL	---	4	3	35x3x350	28	0,5 - 38	1	8
01563 370 3C 0 OL	---	4	3	35x3x350	37	0,5 - 38	1	8

# 1570/28 - 1570/37 - 1570/37S

Serratura a Doppia Mappa da applicare  
4 mandate  
Catenaccio a pioli e scrocco

Double Bitted key rim lock  
4 turns  
Bolt with pins and latch

**SCROCCO REVERSIBILE**

**REVERSIBLE LATCH**

**FINITURA DI SERIE**

- Scatola e coperchio in acciaio zincato
- Catenaccio e scrocco in acciaio cromato

**STANDARD FINISHINGS**

- Box and cover in galvanised steel
- Bolt and latch in chrome-plated steel

**DOTAZIONE**

- 3 chiavi cifrate Art. 204
- Coppia Bocchette con viti Art. 280DM
- 
- 1570/28G Serratura predisposta al montaggio della guida chiave (a richiesta).

**ACCESSORIES**

- 3 keys Art. 204 (coded)
- Pair of escutcheons with screws Art. 280DM
- 
- 1570/28G Lock predisposed for mounting key slot (On request).

Serie 1560-1600

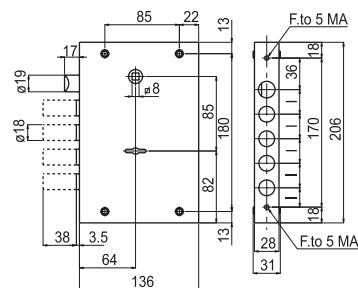

Serrature per porte blindate  
Security door locks

1570		Serratura a Doppia Mappa da applicare   4 mandate   Catenaccio a pioli e scrocco   SCROCCO REVERSIBILE						
		Double Bitted key rim lock   4 turns   Bolt with pins and latch   REVERSIBLE LATCH						
Codice Code	Finitura Finishing							
01570 280 3C 0 OL	---	4	3	-	28	3,5 - 41,5	1	8
01570 370 3C 0 OL	---	4	3	-	37	3,5 - 41,5	1	8
01570 37S 3C 0 OL	---	4	3	-	37	43,5 - 81,5	1	8

# 1571/28 - 1571/37 - 1571/37S

Serratura a Doppia Mappa da applicare  
4 mandate | Triplice chiusura  
Catenaccio a pioli e scrocco

Double Bitted key rim lock  
4 turns | Triple locking  
Bolt with pins and latch

## SCROCCO REVERSIBILE

## REVERSIBLE LATCH

### FINITURA DI SERIE

### STANDARD FINISHINGS

- Scatola e coperchio in acciaio zincato
- Catenaccio e scrocco in acciaio cromato

- Box and cover in galvanised steel
- Bolt and latch in chrome-plated steel

### DOTAZIONE

### ACCESSORIES

- 3 chiavi cifrate Art. 204
- Coppia Bocchette con viti Art. 280DM
- 
- 1571/28G Serratura predisposta al montaggio della guida chiave (a richiesta).

- 3 keys Art. 204 (coded)
- Pair of escutcheons with screws Art. 280DM
- 
- 1571/28G Lock predisposed for mounting key slot (On request).

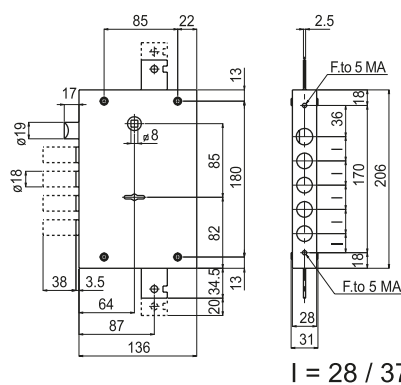

I = 28 / 37

Serie  
1560-1600



Serrature per porte blindate  
Security door locks

1571		Serratura a Doppia Mappa da applicare   4 mandate   Triplice chiusura   Catenaccio a pioli e scrocco   SCROCCO REVERSIBILE						
		Double Bitted key rim lock   4 turns   Triple locking   Bolt with pins and latch   REVERSIBLE LATCH						
Codice Code	Finitura Finishing							
01571 280 3C 0 0L	---	4	3	-	28	3,5 - 41,5	1	8
01571 370 3C 0 0L	---	4	3	-	37	3,5 - 41,5	1	8
01571 37S 3C 0 0L	---	4	3	-	37	43,5 - 81,5	1	8

# 1572/28 - 1572/37 - 1572/37S

Serratura a Doppia Mappa da applicare  
4 mandate  
Catenaccio a pioli

Double Bitted key rim lock  
4 turns  
Bolt with pins

FINITURA DI SERIE

- Scatola e coperchio in acciaio zincato
- Catenaccio in acciaio cromato

STANDARD FINISHINGS

- Box and cover in galvanised steel
- Bolt in chrome-plated steel

DOTAZIONE

- 3 chiavi cifrate Art. 204
- Coppia Bocchette con viti Art. 280DM
- 1572/28G Serratura predisposta al montaggio della guida chiave (a richiesta).

ACCESSORIES

- 3 keys Art. 204 (coded)
- Pair of escutcheons with screws Art. 280DM
- 1572/28G Lock predisposed for mounting key slot (On request).

Serie 1560-1600

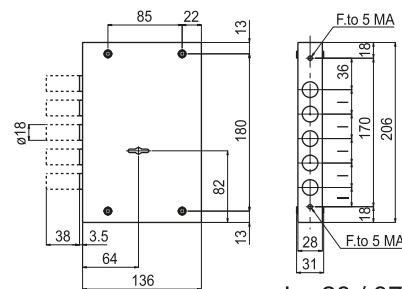

I = 28 / 37

Serrature per porte blindate  
Security door locks

1572

Serratura a Doppia Mappa da applicare | 4 mandate | Catenaccio a pioli

Double Bitted key rim lock | 4 turns | Bolt with pins

Codice Code	Finitura Finishing							
01572 280 3C 0 OL	---	4	3	-	28	3,5 - 41,5	1	8
01572 370 3C 0 OL	---	4	3	-	37	3,5 - 41,5	1	8
01572 37S 3C 0 OL	---	4	3	-	37	43,5 - 81,5	1	8

# 1573/28 - 1573/37 - 1573/37S

Serratura a Doppia Mappa da applicare  
4 mandate | Tripla chiusura  
Catenaccio a pioli

Double Bitted key rim lock  
4 turns | Triple locking  
Bolt with pins

## FINITURA DI SERIE

- Scatola e coperchio in acciaio zincato
- Catenaccio in acciaio cromato

## STANDARD FINISHINGS

- Box and cover in galvanised steel
- Bolt in chrome-plated steel

## DOTAZIONE

- 3 chiavi cifrate Art. 204
- Coppia Bocchette con viti Art. 280DM
- 1573/28G Serratura predisposta al montaggio della guida chiave (a richiesta).

## ACCESSORIES

- 3 keys Art. 204 (coded)
- Pair of escutcheons with screws Art. 280DM
- 1573/28G Lock predisposed for mounting key slot (On request).

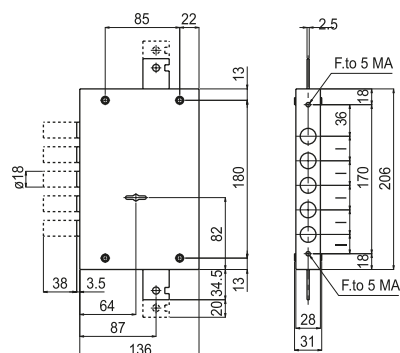

I = 28 / 37

Serie  
1560-1600



Serrature per porte blindate  
Security door locks

1573		Serratura a Doppia Mappa da applicare   4 mandate   Tripla chiusura   Catenaccio a pioli <i>Double Bitted key rim lock   4 turns   Triple locking   Bolt with pins</i>						
Codice Code	Finitura Finishing							
01573 280 3C 0 OL	---	4	3	-	28	3,5 - 41,5	8	
01573 370 3C 0 OL	---	4	3	-	37	3,5 - 41,5	8	
01573 37S 3C 0 OL	---	4	3	-	37	43,5 - 81,5	8	



# 1590/28 - 1590/37

Serratura a Doppia Mappa da infilare  
 4 mandate | Tripla chiusura  
 Catenaccio a pioli e scrocco  
 Aggancio aste chiusura superiore e inferiore con nasello a spillo Art. 247

*Double Bitted key mortice lock  
 4 turns | Triple locking  
 Bolt with pins and latch  
 Rods holder for upper and lower locking with pin catch Art. 247*

## SCROCCO REVERSIBILE

*REVERSIBLE LATCH*

### FINITURA DI SERIE

*STANDARD FINISHINGS*

- Scatola e coperchio in acciaio zincato
- Piastra frontale, catenaccio e scrocco in acciaio cromato

- Box and cover in galvanised steel
- Front plate, bolt and latch in chrome-plated steel

### DOTAZIONE

*ACCESSORIES*

- 3 chiavi cifrate Art. 204
- Coppia Bocchette con viti Art. 280DM
- 
- 1590/28G Serratura predisposta al montaggio della guida chiave (a richiesta).

- 3 keys Art. 204 (coded)
- Pair of escutcheons with screws Art. 280DM
- 
- 1590/28G Lock predisposed for mounting key slot (On request).

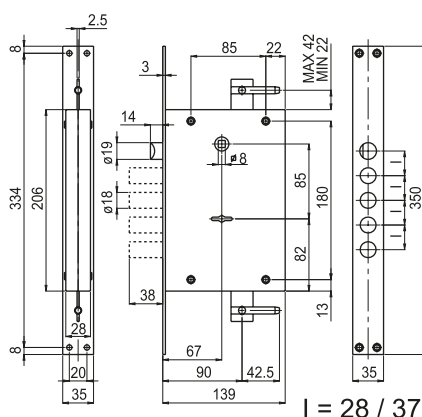

Serie  
1560-1600



Serrature per porte blindate  
Security door locks

1590	Serratura a Doppia Mappa da infilare   4 mandate   Tripla chiusura   Catenaccio a pioli e scrocco Aggancio aste chiusura superiore e inferiore con nasello a spillo Art. 247   SCROCCO REVERSIBILE <i>Double Bitted key mortice lock   4 turns   Triple locking   Bolt with pins and latch          Rods holder for upper and lower locking with pin catch Art. 247            REVERSIBLE LATCH</i>							
	Codice Code	Finitura Finishing						
01590 280 3C 0 OL	---	4	3	35x3x350	28	0,5 - 38	1	8
01590 370 3C 0 OL	---	4	3	35x3x350	37	0,5 - 38	1	8



# 1600

Serratura da infilare con BLOCCO DI SICUREZZA  
Multifunzione a SERRATURE DIPENDENTI  
Azionare la serratura superiore A e poi quella inferiore B

*Double Bitted key mortice lock with SECURITY BLOCK  
Multi-function with DEPENDENT LOCKS  
Operate UPPER lock A and then LOWER lock B*

- SERRATURA SUPERIORE a Doppia Mappa azionamento Catenaccio a pioli e Scrocco | 4 mandate | Triplice chiusura

*- UPPER LOCK with Double Bitted key operated on bolt (4 pins) and latch | 4 turns | Triple locking*

- SERRATURA INFERIORE a Doppia Mappa azionamento Catenaccio un piolo | 2 mandate | Ostruzione foro chiave superiore | Blocco Catenaccio e Aste triplici serratura superiore

*- LOWER LOCK with Double Bitted key operated on service bolt | 2 turns | Upper key hole obstruction | Blocks main locking points*

## SCROCCO REVERSIBILE

*REVERSIBLE LATCH*

### FINITURA DI SERIE

*STANDARD FINISHINGS*

- Scatola e coperchio in acciaio zincato
- Piastra frontale, catenaccio e scrocco in acciaio cromato

- Box and cover in galvanised steel
- Front plate, bolt and latch in chrome-plated steel

### DOTAZIONE

*ACCESSORIES*

- 3 chiavi cifrate Art. 204 per serratura superiore
- 3 chiavi cifrate Art. 204 per serratura inferiore
- 2 Coppie Bocchette con viti Art. 280DM
- 
- A richiesta chiave unica per entrambe le serrature, indicare nell'ordine KA

- 3 keys Art. 204 (coded) for upper lock
- 3 keys Art. 204 (coded) for lower lock
- Two pairs of escutcheons with screws Art. 280 DM.
- 
- On request unique code (keys alike) for both locks, Specify KA in the order

Serie 1560-1600

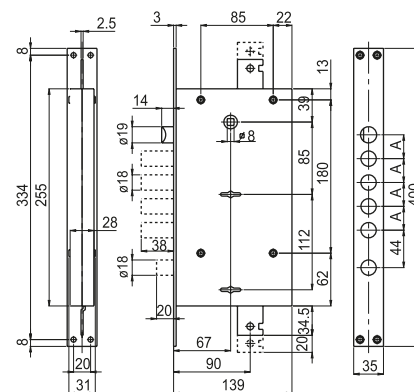

Serrature per porte blindate  
Security door locks

1600

Serratura da infilare con BLOCCO DI SICUREZZA  
Multifunzione a SERRATURE DIPENDENTI  
Azionare la serratura superiore A e poi quella inferiore B |  
- SERRATURA SUPERIORE a Doppia Mappa azionamento Catenaccio a pioli e Scrocco | 4 mandate | Triplice chiusura |  
- SERRATURA INFERIORE a Doppia Mappa azionamento Catenaccio un piolo | 2 mandate | Ostruzione foro chiave superiore |  
Blocco Catenaccio e Aste triplici serratura superiore |  
SCROCCO REVERSIBILE  
*Double Bitted key mortice lock with SECURITY BLOCK  
Multi-function with DEPENDENT LOCKS  
Operate UPPER lock A and then LOWER lock B |  
- UPPER LOCK with Double Bitted key operated on bolt (4 pins) and latch | 4 turns | Triple locking |  
- LOWER LOCK with Double Bitted key operated on service bolt | 2 turns | Upper key hole obstruction | Blocks main locking points |  
REVERSIBLE LATCH*

Codice Code	Finitura Finishing							
01600 280 3C 0 0L	---	4	3	35x3x400	28	0,5 - 38	1	8

# 1602

Serratura da infilare  
Multifunzione a SERRATURE INDIPENDENTI

- SERRATURA SUPERIORE a Doppia Mappa azionamento Catenaccio a pioli e Scrocco | 4 mandate | Triplice chiusura
- SERRATURA INFERIORE a Doppia Mappa azionamento Catenaccio un piolo e scrocco | 2 mandate

## SCROCCO REVERSIBILE

### FINITURA DI SERIE

- Scatola e coperchio in acciaio zincato
- Piastra frontale, catenaccio e scrocco in acciaio cromato

### DOTAZIONE

- 3 chiavi cifrate Art. 204 per serratura superiore
- 3 chiavi cifrate Art. 204 per serratura inferiore
- 2 Coppie Bocchette con viti Art. 280DM
- 
- A richiesta chiave unica per entrambe le serrature, indicare nell'ordine KA

*Double Bitted key mortice lock  
Multi-function with INDEPENDENT LOCKS*

*- UPPER LOCK with Double Bitted key operated on bolt (4 pins) and latch | 4 turns | Triple locking*

*- LOWER LOCK with Double Bitted key operated on service bolt and latch | 2 turns*

## *REVERSIBLE LATCH*

### *STANDARD FINISHINGS*

- *Box and cover in galvanised steel*
- *Front plate, bolt and latch in chrome-plated steel*

### *ACCESSORIES*

- *3 keys Art. 204 (coded) for upper lock*
- *3 keys Art. 204 (coded) for lower lock*
- *Two pairs of escutcheons with screws Art. 280 DM.*
- 
- *On request unique code (keys alike) for both locks, Specify KA in the order*

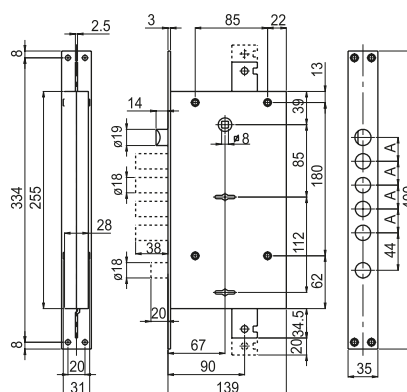

1602	Serratura da infilare Multifunzione a SERRATURE INDIPENDENTI I - SERRATURA SUPERIORE a Doppia Mappa azionamento Catenaccio a pioli e Scrocco   4 mandate   Triplice chiusura   - SERRATURA INFERIORE a Doppia Mappa azionamento Catenaccio un piolo e scrocco   2 mandate   SCROCCO REVERSIBILE <i>Double Bitted key mortice lock Multi-function with INDEPENDENT LOCKS   - UPPER LOCK with Double Bitted key operated on bolt (4 pins) and latch   4 turns   Triple locking   - LOWER LOCK with Double Bitted key operated on service bolt and latch   2 turns   REVERSIBLE LATCH</i>							
	Codice Code	Finitura Finishing						
01602 280 3C 0 OL	---	4	3	35x3x400	28	0,5 - 38	1	8

Serie  
1560-1600



Serrature per porte blindate  
Security door locks

# 1606

Serratura da applicare con BLOCCO DI SICUREZZA  
Multifunzione a SERRATURE DIPENDENTI  
Azionare la serratura superiore A e poi quella inferiore B

*Double Bitted key rim lock with SECURITY BLOCK  
Multi-function with DEPENDENT LOCKS  
Operate UPPER lock A and then LOWER lock B*

- SERRATURA SUPERIORE a Doppia Mappa azionamento Catenaccio a pioli e Scrocco | 4 mandate | Triplice chiusura

*- UPPER LOCK with Double Bitted key operated on bolt (4 pins) and latch | 4 turns | Triple locking*

- SERRATURA INFERIORE a Doppia Mappa azionamento Catenaccio un piolo | 2 mandate | Ostruzione foro chiave superiore | Blocco Catenaccio e Aste triplici serratura superiore

*- LOWER LOCK with Double Bitted key operated on service bolt | 2 turns | Upper key hole obstruction | Blocks main locking points*

## SCROCCO REVERSIBILE

*REVERSIBLE LATCH*

### FINITURA DI SERIE

*STANDARD FINISHINGS*

- Scatola e coperchio in acciaio zincato
- Catenaccio e scrocco in acciaio cromato

- Box and cover in galvanised steel
- Bolt and latch in chrome-plated steel

### DOTAZIONE

*ACCESSORIES*

- 3 chiavi cifrate Art. 204 per serratura superiore
- 3 chiavi cifrate Art. 204 per serratura inferiore
- 2 Coppie Bocchette con viti Art. 280DM
- 
- A richiesta chiave unica per entrambe le serrature, indicare nell'ordine KA

- 3 keys Art. 204 (coded) for upper lock
- 3 keys Art. 204 (coded) for lower lock
- Two pairs of escutcheons with screws Art. 280 DM.
- 
- On request unique code (keys alike) for both locks, Specify KA in the order

Serie 1560-1600

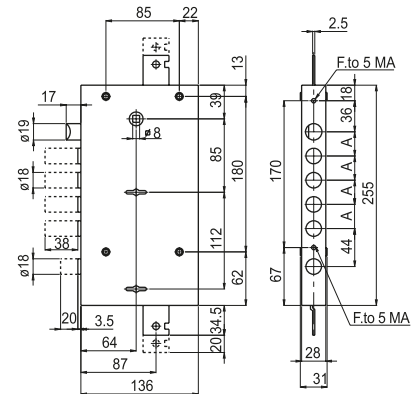

Serrature per porte blindate  
Security door locks

1606	Serratura da applicare con BLOCCO DI SICUREZZA Multifunzione a SERRATURE DIPENDENTI Azionare la serratura superiore A e poi quella inferiore B   - SERRATURA SUPERIORE a Doppia Mappa azionamento Catenaccio a pioli e Scrocco   4 mandate   Triplice chiusura   - SERRATURA INFERIORE a Doppia Mappa azionamento Catenaccio un piolo   2 mandate   Ostruzione foro chiave superiore   Blocco Catenaccio e Aste triplici serratura superiore   SCROCCO REVERSIBILE <i>Double Bitted key rim lock with SECURITY BLOCK Multi-function with DEPENDENT LOCKS Operate UPPER lock A and then LOWER lock B   - UPPER LOCK with Double Bitted key operated on bolt (4 pins) and latch   4 turns   Triple locking   - LOWER LOCK with Double Bitted key operated on service bolt   2 turns   Upper key hole obstruction   Blocks main locking points   REVERSIBLE LATCH</i>							
	Codice Code 01606 280 3C 0 0L	Finitura Finishing ---	4	3	-	28	3,5 - 41,5	1

# 1608

Serratura da applicare  
Multifunzione a SERRATURE INDIPENDENTI

- SERRATURA SUPERIORE a Doppia Mappa azionamento Catenaccio a pioli e Scrocco | 4 mandate | Triplice chiusura
- SERRATURA INFERIORE a Doppia Mappa azionamento Catenaccio un piolo e scrocco | 2 mandate

## SCROCCO REVERSIBILE

### FINITURA DI SERIE

- Scatola e coperchio in acciaio zincato
- Catenaccio e scrocco in acciaio cromato

### DOTAZIONE

- 3 chiavi cifrate Art. 204 per serratura superiore
- 3 chiavi cifrate Art. 204 per serratura inferiore
- 2 Coppie Bocchette con viti Art. 280DM
- 
- A richiesta chiave unica per entrambe le serrature, indicare nell'ordine KA

Double Bitted key rim lock  
Multi-function with INDEPENDENT LOCKS

- UPPER LOCK with Double Bitted key operated on bolt (4 pins) and latch | 4 turns | Triple locking
- LOWER LOCK with Double Bitted key operated on service bolt and latch | 2 turns

## REVERSIBLE LATCH

### STANDARD FINISHINGS

- Box and cover in galvanised steel
- Bolt and latch in chrome-plated steel

### ACCESSORIES

- 3 keys Art. 204 (coded) for upper lock
- 3 keys Art. 204 (coded) for lower lock
- Two pairs of escutcheons with screws Art. 280 DM.
- 
- On request unique code (keys alike) for both locks, Specify KA in the order

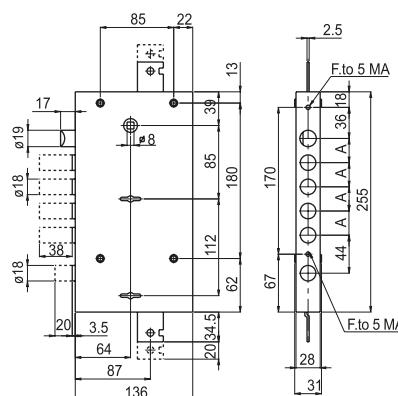

1608	Serratura da applicare Multifunzione a SERRATURE INDIPENDENTI   - SERRATURA SUPERIORE a Doppia Mappa azionamento Catenaccio a pioli e Scrocco   4 mandate   Triplice chiusura   - SERRATURA INFERIORE a Doppia Mappa azionamento Catenaccio un piolo e scrocco   2 mandate   SCROCCO REVERSIBILE Double Bitted key rim lock Multi-function with INDEPENDENT LOCKS   - UPPER LOCK with Double Bitted key operated on bolt (4 pins) and latch   4 turns   Triple locking   - LOWER LOCK with Double Bitted key operated on service bolt and latch   2 turns   REVERSIBLE LATCH							
	Codice Code	Finitura Finishing						
01608 280 3C 0 OL	---	4	3	-	28	3,5 - 41,5	1	8

Serie  
1560-1600



Serrature per porte blindate  
Security door locks

# 1610

Serratura da infilare  
Plurisistema a SERRATURE INDIPENDENTI

Double Bitted key mortice lock  
Multi-system with INDEPENDENT LOCKS

- SERRATURA SUPERIORE a Doppia Mappa azionamento Catenaccio a pioli e Scrocco | 4 mandate | Triplice chiusura

- UPPER LOCK with Double Bitted key operated on bolt (4 pins) and latch | 4 turns | Triple locking

- SERRATURA INFERIORE a Cilindro azionamento Catenaccio un piolo e scrocco | 2 mandate

- LOWER LOCK with Cylinder operated on service bolt and latch | 2 turns

SCROCCO REVERSIBILE

REVERSIBLE LATCH

FINITURA DI SERIE

STANDARD FINISHINGS

- Scatola e coperchio in acciaio zincato
- Piastra frontale, catenaccio e scrocco in acciaio cromato

- Box and cover in galvanised steel
- Front plate, bolt and latch in chrome-plated steel

DOTAZIONE

ACCESSORIES

- 3 chiavi cifrate Art. 204 per serratura superiore
- Coppia Bocchette con viti Art. 280DM

- 3 keys Art. 204 (coded) for upper lock
- Pairs of escutcheons with screws Art. 280 DM.

Serie  
1560-1600

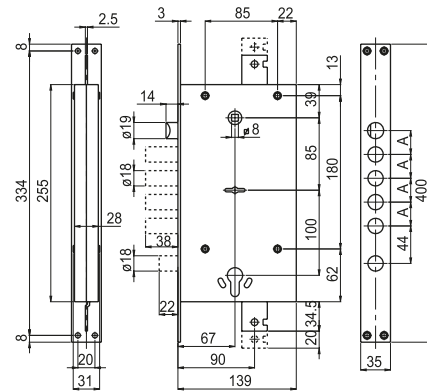

Serrature per porte blindate  
Security door locks

1610	<p>Serratura da infilare Plurisistema a SERRATURE INDIPENDENTI I - SERRATURA SUPERIORE a Doppia Mappa azionamento Catenaccio a pioli e Scrocco   4 mandate   Triplice chiusura   - SERRATURA INFERIORE a Cilindro azionamento Catenaccio un piolo e scrocco   2 mandate   SCROCCO REVERSIBILE</p> <p>Double Bitted key mortice lock Multi-system with INDEPENDENT LOCKS   - UPPER LOCK with Double Bitted key operated on bolt (4 pins) and latch   4 turns   Triple locking   - LOWER LOCK with Cylinder operated on service bolt and latch   2 turns   REVERSIBLE LATCH</p>							
	Codice Code	Finitura Finishing						
01610 280 3C 0 OL	---	4	3	35x3x400	28	0,5 - 38	1	8



# 1616

Serratura da applicare  
Plurisistema a SERRATURE INDIPENDENTI

- SERRATURA SUPERIORE a Doppia Mappa azionamento Catenaccio a pioli e Scrocco | 4 mandate | Triplice chiusura

- SERRATURA INFERIORE a Cilindro azionamento Catenaccio un piolo e scrocco | 2 mandate

SCROCCO REVERSIBILE

FINITURA DI SERIE

- Scatola e coperchio in acciaio zincato
- Catenaccio e scrocco in acciaio cromato

DOTAZIONE

- 3 chiavi cifrate Art. 204 per serratura superiore
- Coppia Bocchette con viti Art. 280DM

Double Bitted key rim lock  
Multi-system with INDEPENDENT LOCKS

- UPPER LOCK with Double Bitted key operated on bolt (4 pins) and latch | 4 turns | Triple locking

- LOWER LOCK with Cylinder operated on service bolt and latch | 2 turns

REVERSIBLE LATCH

STANDARD FINISHINGS

- Box and cover in galvanised steel
- Bolt and latch in chrome-plated steel

ACCESSORIES

- 3 keys Art. 204 (coded) for upper lock
- Pairs of escutcheons with screws Art. 280 DM.

Serie

1560-1600

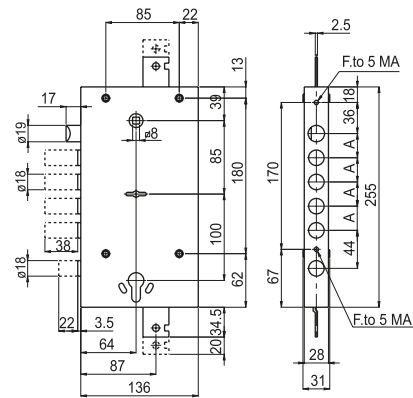

Serrature per porte blindate  
Security door locks

1616	Serratura da applicare Plurisistema a SERRATURE INDIPENDENTI   - SERRATURA SUPERIORE a Doppia Mappa azionamento Catenaccio a pioli e Scrocco   4 mandate   Triplice chiusura   - SERRATURA INFERIORE a Cilindro azionamento Catenaccio un piolo e scrocco   2 mandate   SCROCCO REVERSIBILE							
	Double Bitted key rim lock Multi-system with INDEPENDENT LOCKS   - UPPER LOCK with Double Bitted key operated on bolt (4 pins) and latch   4 turns   Triple locking   - LOWER LOCK with Cylinder operated on service bolt and latch   2 turns   REVERSIBLE LATCH							
Codice Code	Finitura Finishing							
01616 280 3C 0 OL	---	4	3	-	28	3,5 - 41,5	1	8

# 1618

Serratura da applicare con BLOCCO DI SICUREZZA  
Plurisistema a SERRATURE DIPENDENTI  
Azionare la serratura superiore A e poi quella inferiore B

Double Bitted key rim lock with SECURITY BLOCK  
Multi-system with DEPENDENT LOCKS  
Operate UPPER lock A and then LOWER lock B

- SERRATURA SUPERIORE a Doppia Mappa azionamento Catenaccio a pioli e Scrocco | 4 mandate | Triplice chiusura

- UPPER LOCK with Double Bitted key operated on bolt (4 pins) and latch | 4 turns | Triple locking

- SERRATURA INFERIORE a Cilindro azionamento Catenaccio un piolo e scrocco | 2 mandate | Ostruzione foro chiave superiore | Blocco Catenaccio e Aste triplici serratura superiore

- LOWER LOCK with Cylinder operated on service bolt and latch | 2 turns | Upper key hole obstruction | Blocks main locking points

## SCROCCO REVERSIBILE

REVERSIBLE LATCH

## FINITURA DI SERIE

STANDARD FINISHINGS

- Scatola e coperchio in acciaio zincato
- Catenaccio e scrocco in acciaio cromato

- Box and cover in galvanised steel
- Bolt and latch in chrome-plated steel

## DOTAZIONE

ACCESSORIES

- 3 chiavi cifrate Art. 204 per serratura superiore
- Coppia Bocchette con viti Art. 280DM

- 3 keys Art. 204 (coded) for upper lock
- Pairs of escutcheons with screws Art. 280 DM.

Serie  
1560-1600

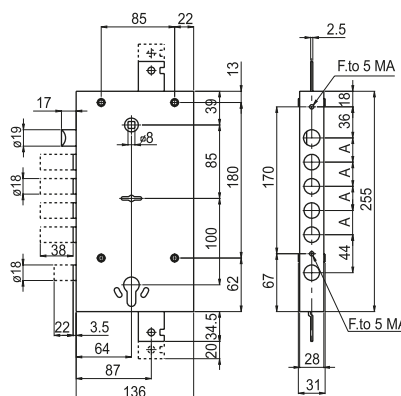

1618	Serratura da applicare con BLOCCO DI SICUREZZA Plurisistema a SERRATURE DIPENDENTI Azionare la serratura superiore A e poi quella inferiore B	
	- SERRATURA SUPERIORE a Doppia Mappa azionamento Catenaccio a pioli e Scrocco   4 mandate   Triplice chiusura	
	- SERRATURA INFERIORE a Cilindro azionamento Catenaccio un piolo e scrocco   2 mandate   Ostruzione foro chiave superiore	
	Blocco Catenaccio e Aste triplici serratura superiore	
SCROCCO REVERSIBILE		
Double Bitted key rim lock with SECURITY BLOCK Multi-system with DEPENDENT LOCKS Operate UPPER lock A and then LOWER lock B		
- UPPER LOCK with Double Bitted key operated on bolt (4 pins) and latch   4 turns   Triple locking		
- LOWER LOCK with Cylinder operated on service bolt and latch   2 turns   Upper key hole obstruction   Blocks main locking points		
REVERSIBLE LATCH		

Codice Code	Finitura Finishing						
01618 280 3C 0 0L	---	4	3	-	28	3,5 - 41,5	1 8



Serrature per porte blindate  
Security door locks



9

Bocchetta interna con copritoppa

FINITURA DI SERIE

- Ottone verniciato

DOTAZIONE

- A richiesta per serrature a doppia mappa Serie 1560 e Serie 1600

Internal escutcheon

STANDARD FINISHINGS

- Lacquered brass

ACCESSORIES

- On request for locks with double bitted keys Series 1560 and Series 1600

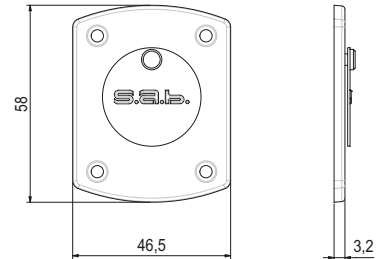

9 Bocchetta interna con copritoppa  
Internal escutcheon

Codice Code	Finitura Finishing			
---	---			
00009 OT		20		
		Finiture Standard   Standard Finishings		Finiture Speciali   Special Finishings
Finitura Finishing		<b>OTO</b>	<b>OLV</b>	<b>OCL ONS</b> <b>OGR OGM</b>
---				



10

Bocchetta esterna

FINITURA DI SERIE

- Ottone verniciato

DOTAZIONE

- A richiesta per serrature a doppia mappa Serie 1560 e Serie 1600

External escutcheon

STANDARD FINISHINGS

- Lacquered brass

ACCESSORIES

- On request for locks with double bitted keys Series 1560 and Series 1600

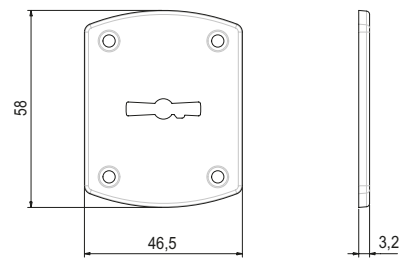

10 Bocchetta esterna  
External escutcheon

Codice Code	Finitura Finishing			
---	---			
00010 OT		20		
		Finiture Standard   Standard Finishings		Finiture Speciali   Special Finishings
Finitura Finishing		<b>OTO</b>	<b>OLV</b>	<b>OCL ONS</b> <b>OGR OGM</b>
---				



# 10Y

Bocchetta esterna  
Foro Cilindro

External escutcheon  
Cylinder hole

FINITURA DI SERIE

STANDARD FINISHINGS

→ Ottone Verniciato

→ Lacquered brass

DOTAZIONE

ACCESSORIES

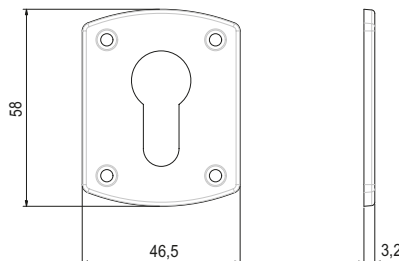

10Y

Bocchetta esterna | Foro Cilindro  
External escutcheon | Cylinder hole

Codice  
Code

Finitura  
Finishing

---

00010 Y OT

10

Finiture Standard | Standard Finishings

Finiture Speciali | Special Finishings

Finitura  
Finishing

**OTO**

**OLV**

**OCL  
ONS**

**OGR  
OGM**

# 280 DM

Bocchetta esterna tonda Dia. 54mm in alluminio con copritoppa  
interno  
Foro Doppia Mappa

Round aluminium escutcheon with hole cover Dia. 54mm  
Double bitted key hole

FINITURA DI SERIE

STANDARD FINISHINGS

→ AOL Alluminio effetto Ottone Lucido

→ AOL Aluminium bright brass effect

A richiesta

On request:

→ ACL Cromo Lucido, ACS Cromo Satinato, ABR Bronzato

→ ACL Bright Chrome, ACS Satin Chrome, ABR Bronze

DOTAZIONE

ACCESSORIES

→ Normale dotazione per serrature a doppia mappa Serie 1560 e  
Serie 1600

→ Standard fitting for locks with double bitted keys Series 1560 e Series  
1600

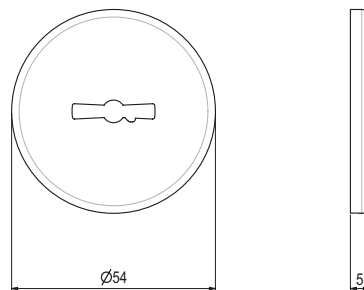

280DM

Bocchetta esterna tonda Dia. 54mm in alluminio con copritoppa interno | Foro Doppia Mappa  
Round aluminium escutcheon with hole cover Dia. 54mm | Double bitted key hole

Codice  
Code

Finitura  
Finishing

---

00280DM

20

Finiture Standard | Standard Finishings

Finiture Speciali | Special Finishings

Finitura  
Finishing

**AOL**

**ACL**

**ACS**

**ABR**



# 280 Y

Bocchetta esterna tonda Dia. 54mm in alluminio  
Foro Cilindro

**FINITURA DI SERIE**

- AOL Alluminio effetto Ottone Lucido
- A richiesta
- ACL Cromo Lucido, ACS Cromo Satinato, ABR Bronzato

**DOTAZIONE**

- A richiesta per serrature a cilindro Serie 1600

Round aluminium escutcheon Dia. 54mm  
Cylinder hole

**STANDARD FINISHINGS**

- AOL Aluminium bright brass effect
- On request:
- ACL Bright Chrome, ACS Satin Chrome, ABR Bronze

**ACCESSORIES**

- On request for locks with cylinder Series 1600

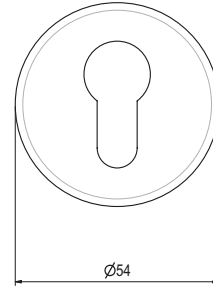

280Y

Bocchetta esterna tonda Dia. 54mm in alluminio | Foro Cilindro  
Round aluminium escutcheon Dia. 54mm | Cylinder hole

Codice Code      Finitura Finishing  
---

00280Y ---



20

Finiture Standard | Standard Finishings

Finiture Speciali | Special Finishings

Finitura Finishing  
---

**AOL**

**ACL**

**ACS**

**ABR**

Serie

1560-1600 Accessories

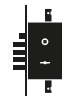

Serrature per porte blindate  
Security door locks

# 254 - 255

Guida chiave in plastica nera prof. 20 o 40mm, per serrature opportunamente predisposte per il montaggio e identificate su questo catalogo con la lettera G.

Key slot in black plastic 20 or 40mm deep for locks already prepared for the mounting and identified in this catalogue with the letter G

**FINITURA DI SERIE**

- Plastica NERA

**STANDARD FINISHINGS**

- BLACK Plastic

**DOTAZIONE**

- Dotazione: viti di montaggio

**ACCESSORIES**

- Included: mounting screws.

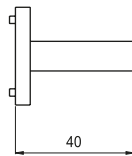
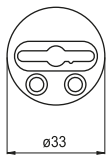

254

Guida chiave in plastica nera profondità 40mm  
Key slot in black plastic 40mm deep

Codice Code      Finitura Finishing  
---

00254



10

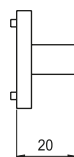
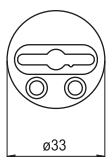

255

Guida chiave in plastica nera profondità 20mm  
Key slot in black plastic 20mm deep

Codice Code      Finitura Finishing  
---

00255



10

# 242

Piastra frontale serrature CATENACCIO  
Interasse Pioli catenaccio 28mm

FINITURA DI SERIE

- Cromatura

DOTAZIONE

- Normale dotazione per Art. 1562/28, 1563/28, 1581/28, 1591/28
- A richiesta per le altre serrature da applicare per porte blindate

Frontal plate for lock BOLT  
Axial distance bolt 28mm

STANDARD FINISHINGS

- Chrome plated

ACCESSORIES

- Standard fitting for Art. 1562/28, 1563/28, 1581/28, 1591/28
- On request, with other rim locks for security doors

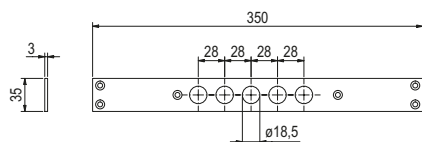

<b>242</b>		Piastra frontale serrature CATENACCIO   Interasse Pioli catenaccio 28mm	
		Frontal plate for lock BOLT   Axial distance bolt 28mm	
Codice Code	Finitura Finishing		
00242	---	10	

# 243

Piastra frontale serrature CATENACCIO e SCROCCO  
Interasse Pioli catenaccio 28mm

FINITURA DI SERIE

- Cromatura

DOTAZIONE

- Normale dotazione per Art. 1560/28, 1561/28, 1580/28, 1590/28
- A richiesta per le altre serrature da applicare per porte blindate

Frontal plate for lock BOLT and LATCH  
Axial distance bolt 28mm

STANDARD FINISHINGS

- Chrome plated

ACCESSORIES

- Standard fitting for Art. 1560/28, 1561/28, 1580/28, 1590/28
- On request, with other rim locks for security doors

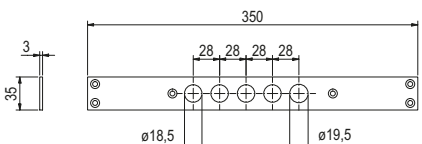

<b>243</b>		Piastra frontale serrature CATENACCIO e SCROCCO   Interasse Pioli catenaccio 28mm	
		Frontal plate for lock BOLT and LATCH   Axial distance bolt 28mm	
Codice Code	Finitura Finishing		
00243	---	10	

# 244

Contropiastra CATENACCIO e SCROCCO  
Interasse Pioli catenaccio 28mm

FINITURA DI SERIE

- Cromatura

DOTAZIONE

- A richiesta per serrature da infilare e applicare per porte blindate

Strike plate BOLT and LATCH  
Axial distance bolt 28mm

STANDARD FINISHINGS

- Chrome plated

ACCESSORIES

- On request, available with mortice or rim locks for security locks

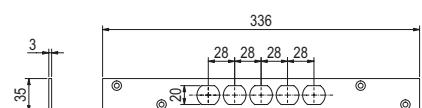

<b>244</b>		Contropiastra CATENACCIO e SCROCCO   Interasse Pioli catenaccio 28mm	
		Strike plate BOLT and LATCH   Axial distance bolt 28mm	
Codice Code	Finitura Finishing		
00244	---	10	



# 251

Piastra frontale serrature CATENACCIO  
Interasse Pioli catenaccio 37mm

**FINITURA DI SERIE**

- Cromatura

**DOTAZIONE**

- Normale dotazione per Art. 1562/37, 1563/37, 1581/37, 1591/37
- A richiesta per le altre serrature da applicare per porte blindate

*Frontal plate for lock BOLT  
Axial distance bolt 37mm*

**STANDARD FINISHINGS**

- Chrome plated

**ACCESSORIES**

- Standard fitting for Art. 1562/37, 1563/37, 1581/37, 1591/37
- On request, with other rim locks for security doors.

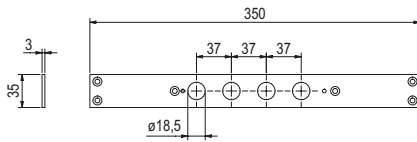

251

Piastra frontale serrature CATENACCIO | Interasse Pioli catenaccio 37mm

*Frontal plate for lock BOLT | Axial distance bolt 37mm*

Codice  
Code

00251

Finitura  
Finishing

---



10



# 252

Piastra frontale serrature CATENACCIO e SCROCCO  
Interasse Pioli catenaccio 37mm

**FINITURA DI SERIE**

- Cromatura

**DOTAZIONE**

- Normale dotazione per Art. 1560/37, 1561/37, 1580/37, 1590/37
- A richiesta per le altre serrature da applicare per porte blindate

*Frontal plate for lock BOLT and LATCH  
Axial distance bolt 37mm*

**STANDARD FINISHINGS**

- Chrome plated

**ACCESSORIES**

- Standard fitting for Art. 1560/37, 1561/37, 1580/37, 1590/37
- On request, with other rim locks for security doors.

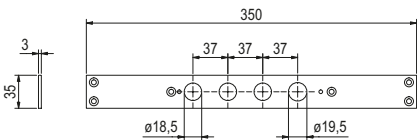

252

Piastra frontale serrature CATENACCIO e SCROCCO | Interasse Pioli catenaccio 37mm

*Frontal plate for lock BOLT and LATCH | Axial distance bolt 37mm*

Codice  
Code

00252

Finitura  
Finishing

---



10

# 253

Contropiastra CATENACCIO e SCROCCO  
Interasse Pioli catenaccio 37mm

**FINITURA DI SERIE**

- Cromatura

**DOTAZIONE**

- A richiesta per le serrature da infilare e applicare per porte blindate,

*Strike plate BOLT and LATCH  
Axial distance bolt 37mm*

**STANDARD FINISHINGS**

- Chrome plated

**ACCESSORIES**

- On request, available with mortice or rim locks for security locks

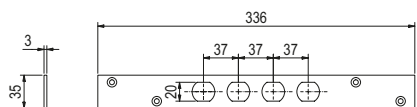

253

Contropiastra CATENACCIO e SCROCCO | Interasse Pioli catenaccio 37mm

*Strike plate BOLT and LATCH | Axial distance bolt 37mm*

Codice  
Code

00253

Finitura  
Finishing

---



10

# 256

Piastra frontale serrature CATENACCIO e SCROCCO + CATENACCIO serratura di servizio  
Serrature multifunzione Doppia Mappa

Frontal plate for lock BOLT and LATCH + service lock BOLT  
Multi-function locks Double Bitted Key

**FINITURA DI SERIE**

→ Cromatura

**STANDARD FINISHINGS**

→ Chrome plated

**DOTAZIONE**

→ Normale dotazione per Art. 1600/28, 1602/28

**ACCESSORIES**

→ Standard fitting for Art. 1600/28, 1602/28

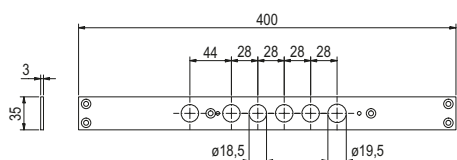

<b>256</b>		Piastra frontale serrature CATENACCIO e SCROCCO + CATENACCIO serratura di servizio   Serrature multifunzione Doppia Mappa	
		Frontal plate for lock BOLT and LATCH + service lock BOLT   Multi-function locks Double Bitted Key	
Codice Code	Finitura Finishing		
00256	---	10	

# 257

Piastra frontale serrature CATENACCIO e SCROCCO + CATENACCIO serratura di servizio  
Serrature plurististema Doppia Mappa + Cilindro

Frontal plate for lock BOLT and LATCH + service lock BOLT  
Multi-system locks Double Bitted Key + Cylinder

**FINITURA DI SERIE**

→ Cromatura

**STANDARD FINISHINGS**

→ Chrome plated

**DOTAZIONE**

→ Normale dotazione per Art. 1610/28, 1612/28

**ACCESSORIES**

→ Standard fitting for Art. 1610/28, 1612/28

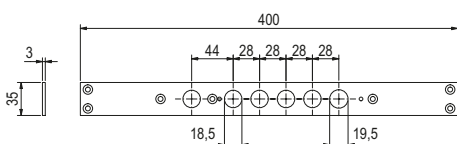

<b>257</b>		Piastra frontale serrature CATENACCIO e SCROCCO + CATENACCIO serratura di servizio   Serrature plurististema Doppia Mappa + Cilindro	
		Frontal plate for lock BOLT and LATCH + service lock BOLT   Multi-system locks Double Bitted Key + Cylinder	
Codice Code	Finitura Finishing		
00257	---	10	

# 258

Contropiastra CATENACCIO e SCROCCO + CATENACCIO serratura di servizio

Strike plate BOLT and LATCH + service lock BOLT

**FINITURA DI SERIE**

→ Cromatura

**STANDARD FINISHINGS**

→ Chrome plated

**DOTAZIONE**

→ A richiesta per serrature da infilare e applicare per porte blindate Art. 1600/28, 1602/28, 1606/28, 1608/28, 1610/28, 1612/28, 1616/28, 1618/28

**ACCESSORIES**

→ On request, available with mortice or rim locks for security doors Art. 1600/28, 1602/28, 1606/28, 1608/28, 1610/28, 1612/28, 1616/28, 1618/28

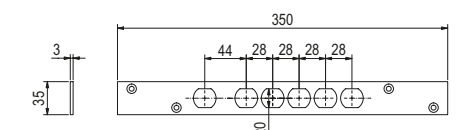

<b>258</b>		Contropiastra CATENACCIO e SCROCCO + CATENACCIO serratura di servizio	
		Strike plate BOLT and LATCH + service lock BOLT	
Codice Code	Finitura Finishing		
00258	---	10	

Serie 1560-1600 Accessories



Serrature per porte blindate  
Security door locks

# 247

Nasello a spillo per aggancio aste

FINITURA DI SERIE

- Cromatura

DOTAZIONE

- Normale dotazione Art. 1590 28/37, 1591 28/37
- A richiesta per le altre serrature da infilare ed applicare per porte blindate
- Completo di spina elastica di montaggio

*Pin catch in steel for holding rods*

STANDARD FINISHINGS

- Chrome plated

ACCESSORIES

- Standard fitting for Art. 1590 28/37 1591 28/37
- On request, available with other mortice or rim locks for security doors
- Completed with elastic mounting plug

247

Nasello a spillo per aggancio aste

*Pin catch in steel for holding rods*

Codice

Finitura

Code

Finishing

00247



10

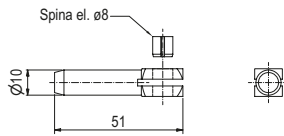

Serie

1560-1600 Accessories



# 248

Nasello a leva per aggancio aste

FINITURA DI SERIE

- Zincatura

DOTAZIONE

- Normale dotazione per Art. 1580 28/37, 1581 28/37
- A richiesta per le altre serrature da infilare ed applicare per porte blindate
- Completo di vite di fissaggio

*Bayonet coupling for rod attachment*

STANDARD FINISHINGS

- Galvanised

ACCESSORIES

- Standard fitting for Art. 1580 28/37 1581 28/37
- On request, available with other mortice or rim locks for security doors
- Completed with elastic mounting plug

248

Nasello a leva per aggancio aste

*Bayonet coupling for rod attachment*

Codice

Finitura

Code

Finishing

00248



10

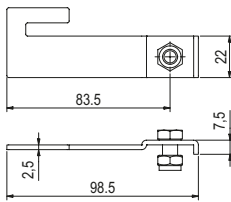

Serrature per porte blindate

*Security door locks*

# 249

Piastra da saldare in acciaio

Soldering Plate in steel

FINITURA DI SERIE

STANDARD FINISHINGS

DOTAZIONE

- A richiesta per l'installazione delle serrature da applicare
- per porte blindate Art. 1570 28/37/37S, 1571 28/37/37S, 1572 28/37/37S, 1573 28/37/37S

ACCESSORIES

- On request, for installation fo rim locks
- for security doors Art. 1570 28/37/37S, 1571 28/37/37S, 1572 28/37/37S, 1573 28/37/37S

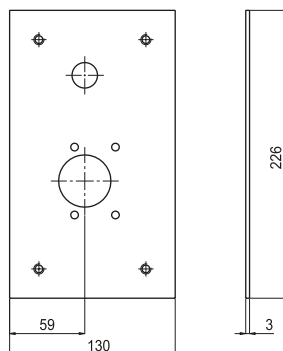

249		Piastra da saldare in acciaio	
		Soldering Plate in steel	
Codice	Finitura		
Code	Finishing		
	---		
00249		10	

Serie 1560-1600 Accessories



# 250

Piastrina antitrapano temprata in acciaio al carbonio

Drill proof tempered plate in carbon steel

FINITURA DI SERIE

STANDARD FINISHINGS

DOTAZIONE

- A richiesta per serrature da applicare per porte blindate
- La piastrina antitrapano viene installata nell'intercapedine che si forma tra la piastra da saldare Art. 249 e la serratura

ACCESSORIES

- On request, available for rim locks for security doors.
- The drill-proof plate is installed in the gap between the soldering plate Art. 249 and the lock.

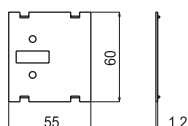

250		Piastrina antitrapano temprata in acciaio al carbonio	
		Drill proof tempered plate in carbon steel	
Codice	Finitura		
Code	Finishing		
	---		
00250		10	



Serrature per porte blindate  
Security door locks



# 260

ASTA DI COLLEGAMENTO deviatori  
Registrazione telescopica da fissare tramite saldatura  
FINITURA DI SERIE

CONNECTING ROD  
Telescopic adjustment to be fixed by welding  
STANDARD FINISHINGS

DOTAZIONE

ACCESSORIES

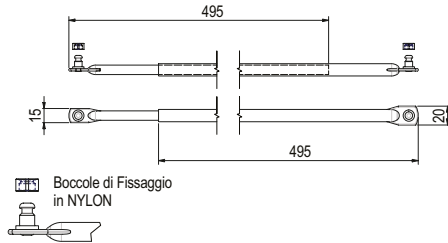

260		ASTA DI COLLEGAMENTO deviatori Registrazione telescopica da fissare tramite saldatura CONNECTING ROD Telescopic adjustment to be fixed by welding		
Codice Code	Finitura Finishing			
00260	---			10

Serie 1560-1600 Accessories



# 261

ASTA CATENACCIO  
Registrazione telescopica da fissare tramite saldatura  
FINITURA DI SERIE  
→ Catenaccio ø18mm in acciaio cromato  
DOTAZIONE

DOOR BOLT ROD  
Telescopic adjustment to be fixed by welding  
STANDARD FINISHINGS  
→ Terminal bolt ø18mm in chrome-plated steel  
ACCESSORIES

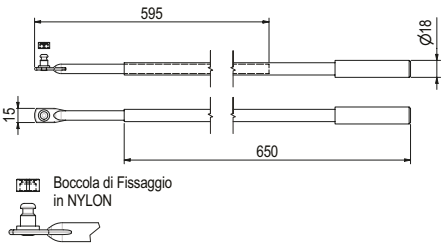

261		ASTA CATENACCIO Registrazione telescopica da fissare tramite saldatura DOOR BOLT ROD Telescopic adjustment to be fixed by welding		
Codice Code	Finitura Finishing			
00261	---			10



Serrature per porte blindate  
Security door locks

# 262

ASTA CATENACCIO SUPERIORE  
Registrazione telescopica da fissare tramite saldatura  
FINITURA DI SERIE  
→ Catenaccio ø18mm in acciaio cromato  
DOTAZIONE

UPPER DOOR BOLT ROD  
Telescopic adjustment to be fixed by welding  
STANDARD FINISHINGS  
→ Terminal bolt ø18mm in chrome-plated steel  
ACCESSORIES

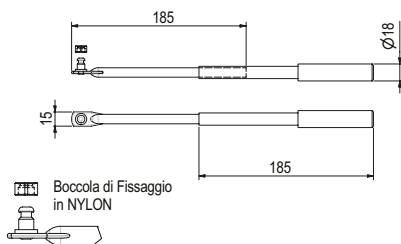

262		ASTA CATENACCIO SUPERIORE Registrazione telescopica da fissare tramite saldatura UPPER DOOR BOLT ROD Telescopic adjustment to be fixed by welding		
Codice Code	Finitura Finishing			
00262	---			10

# 263

Lamierino guida catenaccio a saldare con boccola in nylon, in lamiera di acciaio

*Bolt block sheet for soldering with nylon bushing*

FINITURA DI SERIE

STANDARD FINISHINGS

DOTAZIONE

ACCESSORIES

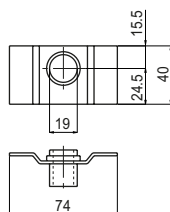

263		Lamierino guida catenaccio a saldare con boccola in nylon, in lamiera di acciaio	
		<i>Bolt block sheet for soldering with nylon bushing</i>	
Codice Code	Finitura Finishing		
00263	---	10	

# 264

Pozzetto in acciaio zincato per catenacci ø18mm

*Socket for door bolts ø18mm in galvanised steel.*

FINITURA DI SERIE

STANDARD FINISHINGS

→ Zincatura

→ Galvanised

DOTAZIONE

ACCESSORIES



264		Pozzetto in acciaio zincato per catenacci ø18mm	
		<i>Socket for door bolts ø18mm in galvanised steel.</i>	
Codice Code	Finitura Finishing		
00264	---	10	

# 265

ASTA CATENACCIO attacco a baionetta  
Registrazione telescopica da fissare tramite saldatura

*DOOR BOLT ROD*  
*Telescopic adjustment to be fixed by welding*

FINITURA DI SERIE

STANDARD FINISHINGS

→ Catenaccio ø18mm in acciaio cromato

→ Terminal bolt ø18mm in chrome-plated steel

DOTAZIONE

ACCESSORIES

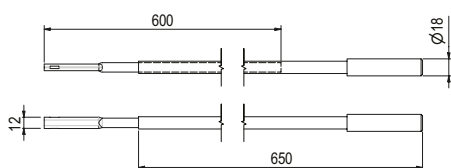

265		ASTA CATENACCIO attacco a baionetta	
		Registrazione telescopica da fissare tramite saldatura	
		<i>DOOR BOLT ROD</i>	
		<i>Telescopic adjustment to be fixed by welding</i>	
Codice Code	Finitura Finishing		
00265	---	10	



# RN1304DX - RN1304SX

Catenaccio deviatore a un chiavistello  
 Il deviatore nel disegno è nella versione destra  
 Applicazione destra (DX) o sinistra (SX)

**FINITURA DI SERIE**

- Scatola e asta in acciaio
- Catenaccio ø18mm in acciaio nichelato

**DOTAZIONE**

*Single plate switch*  
 The switch in the drawing is right hand operation  
 Right (DX) and left (SX) hand operation

**STANDARD FINISHINGS**

- Standard box in steel
- Bolt ø18mm in Nickel-plated steel

**ACCESSORIES**

Serie 1560-1600 Accessories

Serie

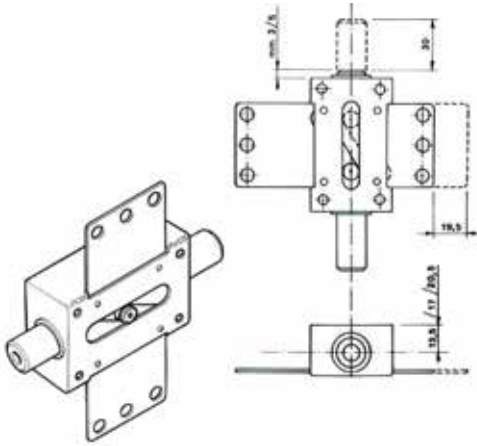

**RN1304**

Catenaccio deviatore a un chiavistello | Il deviatore nel disegno è nella versione destra | Applicazione destra (DX) o sinistra (SX)

*Single plate switch | The switch in the drawing is right hand operation | Right (DX) and left (SX) hand operation*

Codice Code	Finitura Finishing
---	---
RN1304 DX	
RN1304 SX	



1

# RN1308DX - RN1308SX

Catenaccio deviatore a due chiavistelli  
 Il deviatore nel disegno è nella versione destra  
 Applicazione destra (DX) o sinistra (SX)

**FINITURA DI SERIE**

- Scatola e asta in acciaio
- Catenaccio ø18mm in acciaio nichelato

**DOTAZIONE**

*Double plate switch*  
 The switch in the drawing is right hand operation  
 Right (DX) and left (SX) hand operation

**STANDARD FINISHINGS**

- Standard box in steel
- Bolts ø18mm in Nickel-plated steel

**ACCESSORIES**

Serrature per porte blindate  
 Security door locks

Serrature per porte blindate

Security door locks

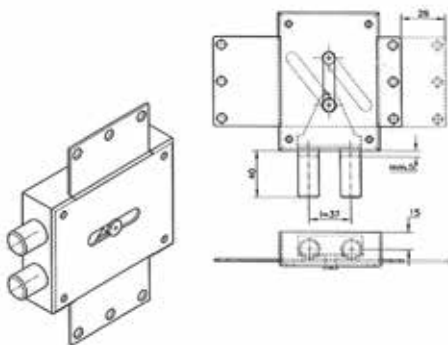

**RN1308**

Catenaccio deviatore a due chiavistelli | Il deviatore nel disegno è nella versione destra | Applicazione destra (DX) o sinistra (SX)

*Double plate switch | The switch in the drawing is right hand operation | Right (DX) and left (SX) hand operation*

Codice Code	Finitura Finishing
---	---
RN1308 DX	
RN1308 SX	



1

